

PLSES

Open Drip Proof three-phase asynchronous motors



General information



Open Drip Proof three-phase asynchronous motors, PLSES series, according to IEC 60034, 60066, 60072 power 30 kW to 900 kW, frame size 180 to 400 mm, 2 and 4 poles; 230/400 V or 400 V Δ , 50 Hz.

Protection

Standard version IP 23 providing excellent motor cooling through internal ventilation.

Main supply

- Standard in accordance with IEC 60038:
- 230/400 V +10% -10% at 50 Hz.
- Standard construction suitable for the following mains supplies:
- 220/380 V or 380 V Δ +5% -5% at 50 Hz,
- 230/400 V or 400 V Δ +10% -10% at 50 Hz,
- 240/415 V or 415 V Δ +5% -5% at 50 Hz,
- 265/460 V or 460 V Δ +5% -5% at 60 Hz.
- Construction suitable the Y/ Δ starting.

Description of the PLSES three-phase motors

Component	Materials	Remarks
Housing	Aluminium or steel	- aluminium: frame size 180 to 200, 250 SP/MP - steel: frame size 225 to 400, except 250 SP/MP - gravity or low pressure casting, frame size \leq 250 - lifting rings
Stator	Insulated low carbon magnetic steel laminations Electrolytic copper	- the low carbon content guarantees long term stability of the characteristics - assembled lamination pack - semi-enclosed slots - insulation system class F
Rotor	Insulated low carbon magnetic steel laminations Aluminium or copper	- inclined slots - rotor cage pressure die cast, in aluminium - rotor cage shrink-fitted to shaft - dynamically balanced rotor, class A - 1/2 key
Shaft	Steel	
End shields	Cast iron or steel	
Bearings and lubrication		Standard mounting: - ball bearings set C3 - sealed and lubricated for life for frame size \leq 200 - regreasable from frame size 225 - rear preloaded bearings
Labyrinth seals Lipseals	Technopolymer or steel Synthetic rubber	- front lipseal for all flange motors
Fan	Composite material Aluminium alloy or steel	- bi-directional fan in 2 poles ($P \leq$ 250 kW), 4 poles for frame size 180 to 315 excepted 315 MGU and LG - unidirectional fan (specify direction of rotation when ordering) in 2 poles, for frame size 315 MGU and LG
Fan cover	Sheet steel	- on request, fitted with a drip cover for operation in vertical position, shaft facing down
Terminal box	Composite material Aluminium alloy or steel	- can be turned in 4 directions, opposite to the feet position - fitted with a terminal block with 6 steel terminals as standard - terminal box fitted with threaded plugs for frame size \leq 280 SD/MD, for motors 280 MG to 315 and above, terminal box fitted with cable gland support plate drilled and removable, without cable gland - 1 earth terminal in all terminal boxes

PLSES

Open Drip Proof three-phase asynchronous motors



Mounting positions

Foot mounted motors

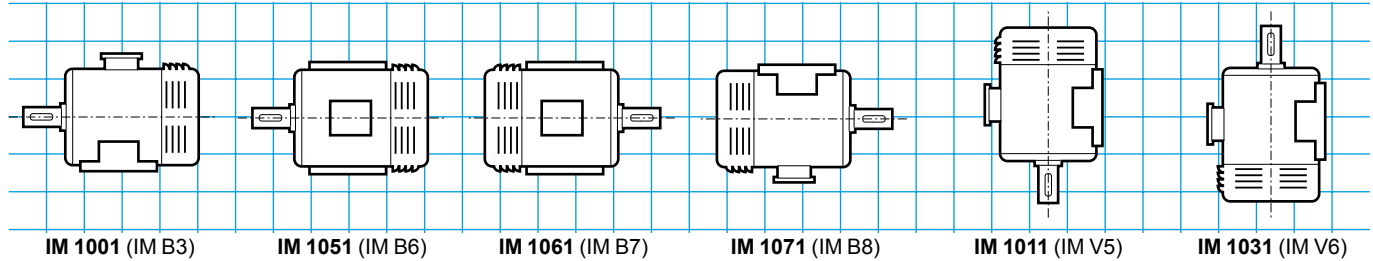

(FF) flange mounted motors with plain holes

- Possible position IM 3001 (IM B5) up to 225 frame size inclusive

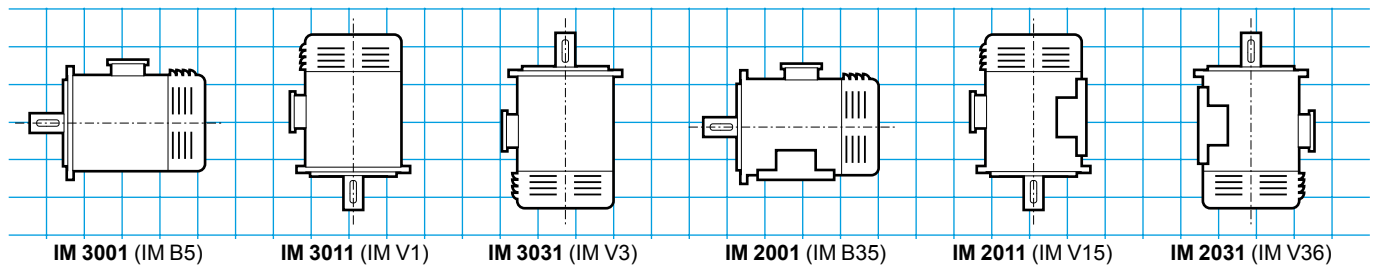

Terminal box position in relation to the motor shaft end

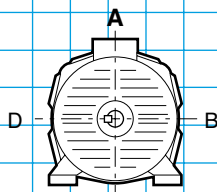

A: standard

Cable gland position in relation to the motor shaft end

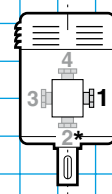

1: standard

* Position 2 not recommended and not feasible on standard flange motor with plain holes (FF)

PLSES

Open Drip Proof three-phase asynchronous motors



Selection

IP 23 - 50 Hz - Class F - ΔT 80 K - 230 V Δ / 400 V Y and 400 V Δ - S1 - Class IE2

2
poles
3000 min⁻¹

IE2

Type	Rated power	Rated speed	Rated torque	Rated current	Power factor			Efficiency IEC 60034-2-1 2007			Starting current / Rated current	Starting torque / Rated torque	Maximum torque / Rated torque	Moment of inertia	Weight	Noise
	P_N	N_N	M_N	$I_{N(400V)}$	Cos φ			η			I_d / I_n	M_d / M_n	M_M / M_n	J	IM B3	LP
	kW	min ⁻¹	N.m	A	4/4	3/4	2/4	4/4	3/4	2/4				kg.m ²	kg	db(A)
PLSES 180 LG	37	2951	120	68	0.85	0.81	0.70	92.8	92.8	91.8	7.4	2.8	3.1	0.081	167	76
PLSES 200 M	45	2952	145	79	0.88	0.85	0.77	93.0	93.4	93.0	7.5	2.8	3.1	0.102	182	76
PLSES 200 LU	55	2950	179	95	0.90	0.88	0.83	93.2	93.4	92.6	7.5	2.8	3.2	0.14	222	78
PLSES 225 MG	75	2974	241	131	0.88	0.84	0.77	93.9	93.8	92.8	8.5	2.5	3.1	0.17	364	78
PLSES 250 SP	90	2972	290	156	0.88	0.84	0.76	94.4	94.2	93.1	8.8	2.6	3.3	0.40	362	79
PLSES 250 MP	110	2970	352	195	0.86	0.83	0.74	94.4	94.4	93.6	8.6	2.6	3.6	0.44	381	79
PLSES 280 MD	132	2963	426	222	0.89	0.88	0.84	94.6	94.5	93.7	9.0	2.9	3.5	0.48	488	79
PLSES 315 S	160	2975	512	270	0.88	0.86	0.80	95.1	95.2	94.9	8.1	2.6	3.4	1.25	640	79
PLSES 315 M	200	2974	642	341	0.89	0.87	0.82	95.1	95.0	94.3	7.8	2.5	3.3	1.42	702	79
PLSES 315 L	250	2971	802	422	0.90	0.89	0.84	95.1	95.1	94.5	8.3	2.9	3.0	1.68	792	79
PLSES 315 LD	280	2973	900	466	0.91	0.90	0.87	95.2	95.4	95.0	8.0	2.8	3.0	1.97	885	85
PLSES 315 LD	315	2972	1008	531	0.90	0.87	0.82	95.1	95.2	94.8	7.5	2.8	3.1	1.97	891	85
PLSES 315 LG	355	2974	1140	608	0.88	0.88	0.81	95.4	95.6	95.0	5.9	1.8	2.3	2.80	1030	85
PLS 315 LG*	400	2965	1288	695	0.87	-	-	94.6	-	-	7.0	1.9	2.0	3.10	1120	89
PLS 315 VLG*	450	2975	1444	778	0.87	-	-	95.1	-	-	7.0	1.9	2.1	3.50	1200	89
PLS 355 LA*	500	2978	1602	761	0.87	-	-	95.1	-	-	5.7	1.3	2.2	6.30	1700	90
PLS 355 LB*	710	2978	2277	1207	0.88	-	-	95.6	-	-	8.4	1.6	2.2	8.00	2050	90

* Motors nonconcerned by IE2

PLSES

Open Drip Proof three-phase asynchronous motors



Selection

IP 23 - 50 Hz - Class F - ΔT 80 K - 230 V Δ / 400 V Y and 400 V Δ - S1 - Class IE2

4
poles
1500 min⁻¹

IE2

Type	Rated power	Rated speed	Rated torque	Rated current	Power factor			Efficiency IEC 60034-2-1 2007			Starting current / Rated current	Starting torque / Rated torque	Maximum torque / Rated torque	Moment of inertia	Weight	Noise
	P_N	N_N	M_N	$I_{N(400V)}$	Cos φ			η			I_d / I_n	M_d / M_n	M_M / M_n	J	IM B3	LP
	kW	min ⁻¹	N.m	A	4/4	3/4	2/4	4/4	3/4	2/4				kg.m ²	kg	db(A)
PLSES 180 LGU	30	1470	195	57	0.82	0.77	0.66	92.4	92.7	92.2	6.5	2.8	2.6	0.123	168	76
PLSES 200 M	37	1469	239	71	0.81	0.76	0.66	92.9	93.6	93.6	6.5	2.7	2.7	0.15	186	76
PLSES 200 LR	45	1471	292	86	0.83	0.79	0.69	93.1	93.8	94.0	6.7	2.7	2.5	0.22	224	78
PLSES 225 MG	55	1482	355	104	0.81	0.76	0.65	93.5	93.7	93.0	7.0	2.6	2.6	0.36	353	78
PLSES 250 SP	75	1483	482	142	0.81	0.75	0.65	94.0	94.1	93.2	7.7	3.0	3.0	0.65	376	79
PLSES 250 MF	90	1480	581	164	0.84	0.80	0.71	94.3	94.6	94.0	7.2	2.7	2.9	0.75	461	79
PLSES 280 SD	110	1479	710	204	0.82	0.77	0.68	94.5	94.8	94.4	7.3	2.8	3.0	0.87	504	79
PLSES 280 MG	132	1485	851	245	0.82	0.78	0.68	94.8	94.7	93.8	7.6	2.8	3.1	1.07	698	79
PLSES 315 SUR	160	1486	1030	295	0.82	0.77	0.67	94.9	94.5	93.5	8.3	3.0	2.8	2.07	836	79
PLSES 315 MUR	200	1488	1282	370	0.82	0.78	0.68	95.1	95.2	94.6	8.5	3.1	3.4	2.48	942	79
PLSES 315 LDS	250	1482	1628	446	0.85	0.81	0.72	95.2	95.3	94.6	6.7	2.4	2.5	2.96	906	85
PLSES 315 LU	280	1481	1817	511	0.83	0.79	0.70	95.3	95.6	95.4	6.8	2.5	2.8	3.45	952	85
PLSES 315 MGU	315	1487	2023	562	0.85	0.82	0.72	95.2	95.3	94.7	6.6	2.2	2.8	4.60	1122	84
PLSES 315 LG	355	1488	2278	633	0.85	0.80	0.70	95.3	95.3	94.8	6.9	2.3	3.0	5.10	1153	84
PLS 315 LG*	400	1477	2586	724	0.84	-	-	94.1	-	-	6.0	1.7	2.1	5.90	1130	86
PLS 315 VLG*	450	1480	2904	804	0.85	-	-	94.1	-	-	6.0	1.7	2.1	6.30	1280	86
PLS 315 VLGU**	500	1479	3228	889	0.85	-	-	94.6	-	-	6.0	1.6	2.1	6.80	1350	86
PLS 355 LA*	550	1487	3532	973	0.85	-	-	95.1	-	-	6.8	1.6	2.2	10.5	1900	90
PLS 355 LB*	685	1488	4396	1211	0.85	-	-	95.1	-	-	7.0	1.6	2.2	12.0	2150	90
PLS 400 LA*	720	1491	4611	1267	0.85	-	-	95.6	-	-	7.5	1.7	2.2	21.6	2600	91
PLS 400 LB*	900	1491	5764	1584	0.85	-	-	95.6	-	-	7.0	1.7	2.2	27.0	3050	91

* Motors nonconcerned by IE2

PLSES

Open Drip Proof three-phase asynchronous motors



Dimensions

Dimensions of the PLSES open drip proof three-phase asynchronous motors - IP 23

Cage rotor

Dimensions in millimetres

- shaft end

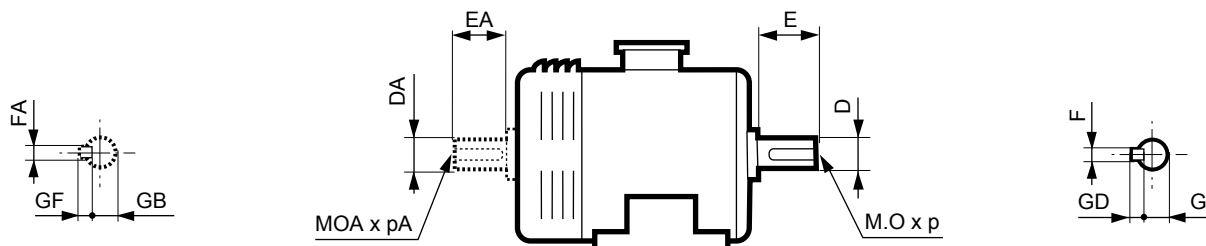

Type	Main shaft end													
	4 poles							2 poles						
	F	GD	D	G	E	O	p	F	GD	D	G	E	O	p
PLSES 180 LG/LGU	16	10	55m6	49	110	20	42	16	10	55m6	49	110	20	42
PLSES 200 M/LR	18	11	60m6	53	140	20	42	18	10	60m6	53	140	20	42
PLSES 225 MG	18	11	65m6	58	140	20	42	18	11	60m6	53	140	20	42
PLSES 250 SP/MP/MF	20	12	75m6	67.5	140	20	42	18	11	65m6	58	140	20	42
PLSES 280 MD/MG	22	14	80m6	71	170	20	42	18	11	65m6	58	140	20	42
PLSES 315 S/SUR/L/LD/LDS/M/MUR	25	14	90m6	81	170	24	50	20	12	70m6	62.5	140	20	42
PLSES 315 LU/LD	28	16	100m6	90	210	24	50	22	14	80m6	71	170	20	42
PLSES 315 LG/MGU/VLG/VLGU	28	16	100m6	90	210	24	50	22	14	80m6	71	170	20	42
PLS 355 L	28	16	110m6	100	210	24	50	22	14	80m6	71	170	20	42
PLS 400 L	32	18	120m6	109	210	24	50	-	-	-	-	-	-	-

Type	Secondary shaft end													
	4 poles							2 poles						
	FA	GF	DA	GB	EA	OA	pA	FA	GF	DA	GB	EA	OA	pA
PLSES 180 LG/LGU	16	10	55m6	49	110	20	42	16	10	55m6	49	110	20	42
PLSES 200 M/LR	18	11	55m6	49	110	20	42	16	10	55m6	49	110	20	42
PLSES 225 MG	18	11	65m6	58	140	20	42	18	11	60m6	53	140	20	42
PLSES 250 SP/MP/MF	20	12	65m6	58	140	20	42	18	11	65m6	58	140	20	42
PLSES 280 MD/MG	20	12	65m6	58	140	20	42	18	11	65m6	58	140	20	42
PLSES 315 S/SUR/L/LDS/M/MUR	20	12	75m6	67.5	140	20	42	18	11	70m6	62.5	140	20	42
PLSES 315 LU/LD	20	12	75m6	67.5	140	20	42	18	11	70m6	62.5	140	20	42
PLSES 315 LG/MGU/VLG/VLGU	22	14	80m6	71	170	20	42	22	14	80m6	71	170	20	42
PLS 355 L	28	16	110m6	100	210	24	50	22	14	80m6	71	170	20	42
PLS 400 L	32	18	120m6	109	210	24	50	-	-	-	-	-	-	-

PLSES

Open Drip Proof three-phase asynchronous motors



Dimensions

Dimensions of the PLSES open drip proof three-phase asynchronous motors - IP 23

Cage rotor

Dimensions in millimetres

– foot mounted

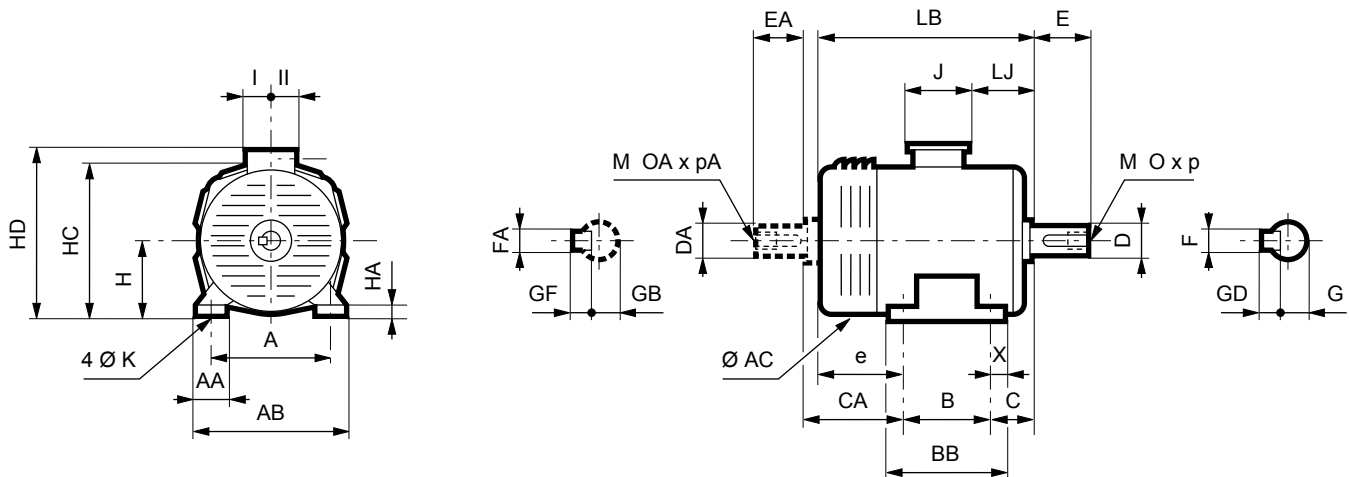

Type	Main dimensions																
	A	AB	B	BB	C	X	AA	K	HA	H	AC	HD	LB	LJ	J	I	II
PLSES 180 LG	279	344	279	323	121	22	60	14.5	30	180	387	451	580	177	186	112	98
PLSES 180 LGU	279	344	279	323	121	22	60	14.5	30	180	387	451	630	177	186	112	98
PLSES 200 LR	318	378	305	345	133	20	60	18.5	32	200	437	496	707.5	213.5	186	112	98
PLSES 200 LU	318	378	305	345	133	20	60	18.5	32	200	437	496	692.5	213.5	186	112	98
PLSES 200 M	318	378	267	347	133	20	60	18.5	30	200	387	471	630	177	186	112	98
PLSES 225 MG	356	416	311	351	149	20	60	18.5	26	225	443	629	824	175.5	292	151	181
PLSES 250 MF	406	466	349	397	168	24	60	24	26	250	443	654	904	209	292	151	181
PLSES 250 MP	406	470	349	400	168	26	94	24	40	250	490	643	779	157.5	292	151	181
PLSES 250 SP	406	470	311	400	168	26	94	24	40	250	490	643	779	157.5	292	151	181
PLSES 280 MD	457	517	419	467	190	24	60	24	26	280	443	684	904	209	292	151	181
PLSES 280 MG	457	537	419	499	190	40	80	24	27	280	548	830	940	242	418	180	236
PLSES 280 SD	457	517	419	467	190	24	60	24	26	280	443	684	904	209	292	151	181
PLSES 315 L	508	608	508	588	216	40	100	28	26	315	548	865	1026	242	418	180	236
PLSES 315 LD/LDS	508	608	508	588	216	40	100	28	26	315	548	865	1086	242	418	180	236
PLSES 315 LG	508	608	508	588	216	40	100	27	26	315	660	880	1141	248	418	206	206
PLSES 315 LU	508	608	508	588	216	40	100	28	26	315	548	865	1106	242	418	180	236
PLSES 315 M	508	608	457	537	216	40	100	28	26	315	600	865	940	242	418	180	236
PLSES 315 MGU	508	608	457	588	216	40	100	28	26	315	660	880	1141	248	418	206	206
PLSES 315 MUR	508	608	457	537	216	40	100	28	26	315	600	865	1106	242	418	180	236
PLSES 315 S	508	608	406	486	216	40	100	28	26	315	600	865	881	242	418	180	236
PLSES 315 SUR	508	608	406	486	216	40	100	28	26	315	600	865	1026	242	418	180	236
PLS 315 VLG	508	608	560	640	216	40	100	27	26	315	660	890	1191	248	428	205	195
PLS 315 VLGU	508	608	560	640	216	40	100	27	26	315	660	890	1261	248	428	205	195
PLS 355 L	610	710	630	710	254	30	100	27	26	355	705	1078	1470	130	700	224	396
PLS 400 L	686	806	710	800	280	45	80	35	26	400	795	1173	1755	177	700	224	396

PLSES

Open Drip Proof three-phase asynchronous motors



Dimensions

Dimensions of the PLSES open drip proof three-phase asynchronous motors - IP 23

Cage rotor

Dimensions in millimetres

– (FF) foot and plain hole flange mounted

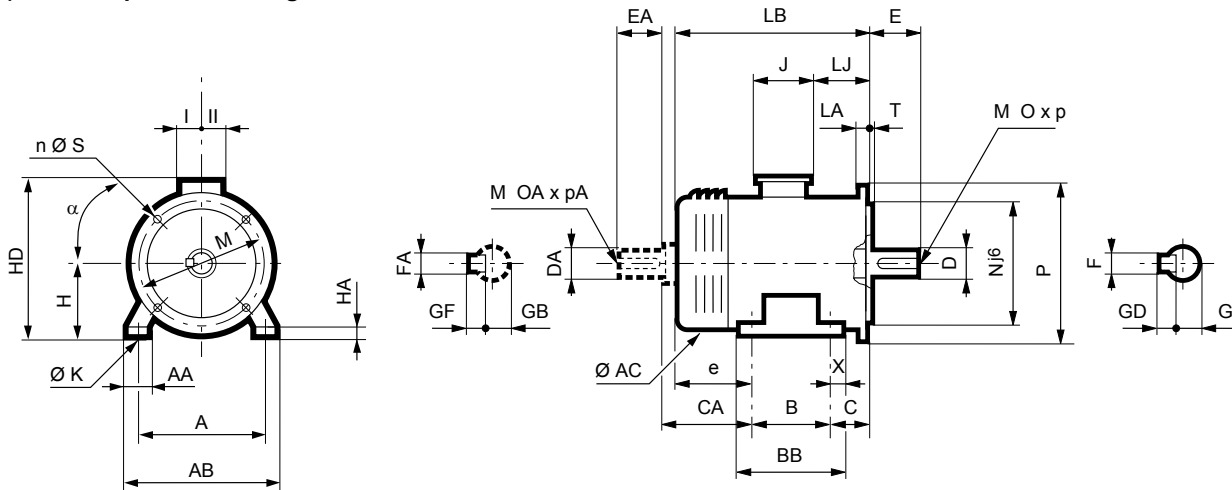

Main dimensions

Type	A	AB	B	BB	C	X	AA	K	HA	H	AC	HD	HJ	LB	LJ	J	I	II	Symb
PLSES 180 LG	279	344	279	323	121	22	60	14.5	30	180	387	451	271	580	177	186	112	98	FF 350
PLSES 180 LGU	279	344	279	323	121	22	60	14.5	30	180	387	451	271	630	177	186	112	98	FF 350
PLSES 200 LR	318	378	305	345	133	20	60	18.5	32	200	437	496	296	707.5	213.5	186	112	98	FF 400
PLSES 200 LU	318	378	305	345	76	20	60	18.5	32	200	437	496	296	692.5	213.5	186	112	98	FF 400
PLSES 200 M	318	378	267	347	76	20	60	18.5	30	200	387	471	271	630	177	186	112	98	FF 400
PLSES 225 MG	356	416	311	351	76	20	60	18.5	26	225	443	629	404	824	175.5	292	151	181	FF 500
PLSES 250 MF*	406	466	349	397	168	24	60	24	26	250	443	654	404	904	209	292	151	181	FF 600
PLSES 250 MP*	406	470	349	400	168	26	94	24	40	250	490	643	393	779	157.5	292	151	181	FF 600
PLSES 250 SP*	406	470	311	400	168	26	94	24	40	250	490	643	393	779	157.5	292	151	181	FF 600
PLSES 280 MD*	457	517	419	467	190	24	60	24	26	280	443	684	404	904	209	292	151	181	FF 600
PLSES 280 MG*	457	537	419	499	190	40	80	24	27	280	548	830	550	940	242	418	180	236	FF 600
PLSES 280 SD*	457	517	419	467	190	24	60	24	26	280	443	684	404	904	209	292	151	181	FF 600
PLSES 315 L*	508	608	508	588	216	40	100	28	26	315	548	865	550	1026	242	418	180	236	FF 740
PLSES 315 LD/LDS*	508	608	508	588	216	40	100	28	26	315	548	865	550	1086	242	418	180	236	FF 740
PLSES 315 LG*	508	608	508	588	216	40	100	28	26	315	660	880	565	1141	248	418	206	206	FF 740
PLSES 315 LU*	508	608	508	588	216	40	100	28	26	315	548	865	550	1106	242	418	180	236	FF 740
PLSES 315 M*	508	608	457	537	216	40	100	28	26	315	600	865	550	940	242	418	180	236	FF 740
PLSES 315 MGU*	508	608	457	588	216	40	100	28	26	315	660	880	565	1141	248	418	206	206	FF 740
PLSES 315 MUR*	508	608	457	537	216	40	100	28	26	315	600	865	550	1106	242	418	180	236	FF 740
PLSES 315 S*	508	608	406	486	216	40	100	28	26	315	600	865	550	881	242	418	180	236	FF 740
PLSES 315 SUR*	508	608	406	486	216	40	100	28	26	315	600	865	550	1026	242	418	180	236	FF 740
PLS 315 VLG	508	608	560	640	216	40	100	27	26	315	660	890	575	1191	248	428	205	195	FF 740
PLS 315 VLGU	508	608	560	640	216	40	100	27	26	315	660	890	575	1261	248	428	205	195	FF 740
PLS 355 L	610	710	630	710	254	30	100	27	26	355	705	1078	723	1470	130	700	224	396	FF 940
PLS 400 L	686	806	710	800	280	45	100	35	26	400	795	1173	773	1755	177	700	224	396	FF 940

* For frame size ≥ 250 mm IM B5 (IM 3001), consult us

IEC symbol	Flange dimensions							
	M	N	P	T	n	α°	S	LA
FF 350	350	300	400	5	4	45	18.5	15
FF 400	400	350	450	5	8	22.5	18.5	16
FF 500	500	450	550	5	8	22.5	18.5	18
FF 600	600	550	660	6	8	22.5	24	25
FF 740	740	680	800	6	8	22.5	24	25
FF 940	940	880	1000	6	8	22.5	28	28
FF 1080	1080	1000	1150	6	8	22.5	28	30

PLSES

Open Drip Proof three-phase asynchronous motors



Dimensions

Dimensions of the PLSES open drip proof three-phase asynchronous motors - IP 23

Cage rotor

Dimensions in millimetres

- (FF) flange mounted with plain holes

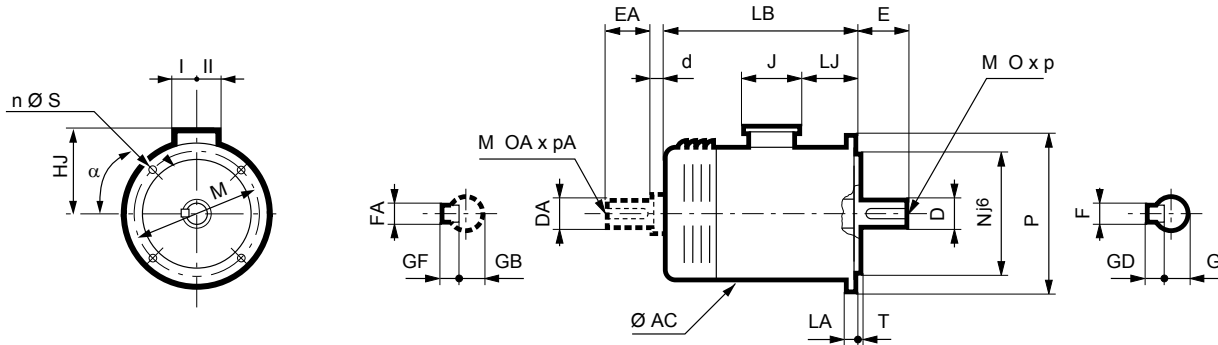

Type	Main dimensions																		Symb
	A	AB	B	BB	C	X	AA	K	HA	H	AC	HD	HJ	LB	LJ	J	I	II	
PLSES 180 LG	279	344	279	323	121	22	60	14.5	30	180	387	451	271	580	177	186	112	98	FF 350
PLSES 180 LGU	279	344	279	323	121	22	60	14.5	30	180	387	451	271	630	177	186	112	98	FF 350
PLSES 200 LR	318	378	305	345	133	20	60	18.5	32	200	437	496	296	707.5	213.5	186	112	98	FF 400
PLSES 200 LU	318	378	305	345	76	20	60	18.5	32	200	437	496	296	692.5	213.5	186	112	98	FF 400
PLSES 200 M	318	378	267	347	76	20	60	18.5	30	200	387	471	271	630	177	186	112	98	FF 400
PLSES 225 MG	356	416	311	351	76	20	60	18.5	26	225	443	629	404	824	175.5	292	151	181	FF 500
PLSES 250 MF*	406	466	349	397	168	24	60	24	26	250	443	654	404	904	209	292	151	181	FF 600
PLSES 250 MP*	406	470	349	400	168	26	94	24	40	250	490	643	393	779	157.5	292	151	181	FF 600
PLSES 250 SP*	406	470	311	400	168	26	94	24	40	250	490	643	393	779	157.5	292	151	181	FF 600
PLSES 280 MD*	457	517	419	467	190	24	60	24	26	280	443	684	404	904	209	292	151	181	FF 600
PLSES 280 MG*	457	537	419	499	190	40	80	24	27	280	548	830	550	940	242	418	180	236	FF 600
PLSES 280 SD*	457	517	419	467	190	24	60	24	26	280	443	684	404	904	209	292	151	181	FF 600
PLSES 315 L*	508	608	508	588	216	40	100	28	26	315	548	865	550	1026	242	418	180	236	FF 740
PLSES 315 LD/LDS*	508	608	508	588	216	40	100	28	26	315	548	865	550	1086	242	418	180	236	FF 740
PLSES 315 LG*	508	608	508	588	216	40	100	28	26	315	660	880	565	1141	247	428	206	206	FF 740
PLSES 315 LU*	508	608	508	588	216	40	100	28	26	315	548	865	550	1106	242	418	180	236	FF 740
PLSES 315 M*	508	608	457	537	216	40	100	28	26	315	600	865	550	940	242	418	180	236	FF 740
PLSES 315 MGU*	508	608	457	588	216	40	100	28	26	315	660	880	565	1141	252	428	206	206	FF 740
PLSES 315 MUR*	508	608	457	537	216	40	100	28	26	315	600	865	550	1106	242	418	180	236	FF 740
PLSES 315 S*	508	608	406	486	216	40	100	28	26	315	600	865	550	881	242	418	180	236	FF 740
PLSES 315 SUR*	508	608	406	486	216	40	100	28	26	315	600	865	550	1026	242	418	180	236	FF 740
PLS 315 VLG	508	608	560	640	216	40	100	27	26	315	660	890	575	1191	248	428	205	195	FF 740
PLS 315 VLGU	508	608	560	640	216	40	100	27	26	315	660	890	575	1261	248	428	205	195	FF 740
PLS 355 L	610	710	630	710	254	30	100	27	26	355	705	1078	723	1470	130	700	224	396	FF 940
PLS 400 L	686	806	710	800	280	45	100	35	26	400	795	1173	773	1755	177	700	224	396	FF 940

* For frame size ≥ 250 mm IM B5 (IM 3001), consult us

IEC symbol	Flange dimensions							
	M	N	P	T	n	α°	S	LA
FF 350	350	300	400	5	4	45	18.5	15
FF 400	400	350	450	5	8	22.5	18.5	16
FF 500	500	450	550	5	8	22.5	18.5	18
FF 600	600	550	660	6	8	22.5	24	25
FF 740	740	680	800	6	8	22.5	24	25
FF 940	940	880	1000	6	8	22.5	28	28
FF 1080	1080	1000	1150	6	8	22.5	28	30

PLSES

Open Drip Proof three-phase asynchronous motors



Lead times

2
poles
3000 min⁻¹

IP 23 - 50 Hz - Class F - ΔT 80 K - 230 V Δ / 400 V Y - S1 - Class IE2

Type	Rated power at 50 Hz P_N kW	IM 1001 (IM B3)		IM 3001 (IM B5)		IM 2001 (IM B35)	
		Code	Qty	Code	Qty	Code	Qty
PLSES 180 LG	37	4747819	1		-	4747821	1
PLSES 200 M	45	4747823	1		-	4747825	1
PLSES 200 LU	55	4747827	1		-	4747829	1
PLSES 225 MG	75	4747831	1		-	4747833	1
PLSES 250 SP	90		-		-		-
PLSES 250 MP	110		-		-		-
PLSES 280 MD	132		-		-		-
PLSES 315 S	160		-		-		-
PLSES 315 M	200		-		-		-
PLSES 315 L	250		-		-		-
PLSES 315 LD	280		-		-		-
PLSES 315 LD	315		-		-		-
PLSES 315 LG	355		-		-		-
PLS 315 LG	400		-		-		-
PLS 315 VLG	450		-		-		-
PLS 355 LA	500		-		-		-
PLS 355 LB	710		-		-		-

2
poles
3000 min⁻¹

IP 23 - 50 Hz - Class F - ΔT 80 K - 400 V Δ - S1 - Class IE2

Type	Rated power at 50 Hz P_N kW	IM 1001 (IM B3)		IM 3001 (IM B5)		IM 2001 (IM B35)	
		Code	Qty	Code	Qty	Code	Qty
PLSES 180 LG	37		-		-		1
PLSES 200 M	45	4747824	1		-	4747826	1
PLSES 200 LU	55	4747828	1		-	4747830	1
PLSES 225 MG	75	4747832	1		-	4747834	1
PLSES 250 SP	90	4747974 *	1		-	4747805	1
PLSES 250 MP	110	4747945 *	1		-	4747809	1
PLSES 280 MD	132	4747948 *	1		-	4747811	1
PLSES 315 S	160	4747950 *	1		-	4747813	1
PLSES 315 M	200	4747952 *	1		-	4747800	1
PLSES 315 L	250	4747953 *	1		-	4747801	1
PLSES 315 LD	280	4747816	1		-	4747803	1
PLSES 315 LD	315	4747817	1		-		-
PLSES 315 LG	355	4747818	1		-		-
PLS 315 LG	400		-		-		-
PLS 315 VLG	450		-		-		-
PLS 355 LA	500		-		-		-
PLS 355 LB	710		-		-		-

* motor fitted with CTP

DG < 2 WD < 5 WD < To agree

DG: Availability ; n WD: Working Days (at the departure of the factory).

PLSES

Open Drip Proof three-phase asynchronous motors



Lead times

4
poles
1500 min⁻¹

IP 23 - 50 Hz - Class F - ΔT 80 K - 230 V Δ / 400 V Y - S1 - Class IE2

Type	Rated power at 50 Hz P_N kW	IM 1001 (IM B3)		IM 3001 (IM B5)		IM 2001 (IM B35)	
		Code	Qty	Code	Qty	Code	Qty
PLSES 180 LGU	30		-		-	4747867	1
PLSES 200 M	37	4747846	1		-	4747848	1
PLSES 200 LR	45	4747852	1		-	4747850	1
PLSES 225 MG	55	4747854	1		-	4747856	1
PLSES 250 SP	75	4747858	1		-	4747860	1
PLSES 250 MF	90		-		-		-
PLSES 280 SD	110		-		-		-
PLSES 280 MG	132		-		-		-
PLSES 315 SUR	160		-		-		-
PLSES 315 MUR	200		-		-		-
PLSES 315 LDS	250		-		-		-
PLSES 315 LU	280		-		-		-
PLSES 315 MG	280		-		-		-
PLSES 315 MGU	315		-		-		-
PLSES 315 LG	355		-		-		-
PLS 315 LG	400		-		-		-
PLS 315 VLG	450		-		-		-
PLS 315 VLGU	500		-		-		-
PLS 355 LA	550		-		-		-
PLS 355 LB	685		-		-		-
PLS 400 LA	720		-		-		-
PLS 400 LB	900		-		-		-

4
poles
1500 min⁻¹

IP 23 - 50 Hz - Class F - ΔT 80 K - 400 V Δ - S1 - Class IE2

Type	Rated power at 50 Hz P_N kW	IM 1001 (IM B3)		IM 3001 (IM B5)		IM 2001 (IM B35)	
		Code	Qty	Code	Qty	Code	Qty
PLSES 180 LGU	30		-		-		-
PLSES 200 M	37		-		-		-
PLSES 200 LR	45	4747853	1		-	4747851	1
PLSES 225 MG	55	4747855	1		-	4747857	1
PLSES 250 SP	75	4747997 *	1		-	4747861	1
PLSES 250 MF	90	4748001 *	2		-	4747865	1
PLSES 280 SD	110	4747976 *	1		-	4747871	1
PLSES 280 MG	132	4747977 *	1		-	4747873	1
PLSES 315 SUR	160	4747978 *	1		-	4747877	1
PLSES 315 MUR	200	4747841	1		-	4747878	1
PLSES 315 LDS	250	4747842	1		-	4747844	1
PLSES 315 LU	280	4747843	1		-	4747879	1
PLSES 315 MGU	315	4747845	1		-		-
PLSES 315 LG	355	4747802	1		-		-
PLS 315 LG	400		-		-		-
PLS 315 VLG	450		-		-		-
PLS 315 VLGU	500		-		-		-
PLS 355 LA	550		-		-		-
PLS 355 LB	685		-		-		-
PLS 400 LA	720		-		-		-
PLS 400 LB	900		-		-		-

* motor fitted with CTP

DG < 2 WD < 5 WD < To agree

DG: Availability ; n WD: Working Days (at the departure of the factory).

PLSES

Open Drip Proof three-phase asynchronous motors





Lead times

Selection table of options for PLSES open drip proof three-phase asynchronous motors - IP 23
Cage rotor

2 poles
3000 min⁻¹

4 poles
1500 min⁻¹

Type	Anti-condensation heaters Code	Roller bearings Code
PLSES 180	MAPT 1011	MAPT 1011
PLSES 200	MAPT 1011	MAPT 1011
PLSES 225	MAPT 1011	MAPT 1011
PLSES 250	MAPT 1011	MAPT 1011
PLSES 280	MAPT 1011	MAPT 1011
PLSES 315 S/IM/LD	MAPT 1011	MAPT 1011
PLSES 315 MG/LG/LD	MAPT 1011	
PLS 355		
PLS 400		

Type	PTO Thermal protections opening (n/c)  Code	PTF Thermal protections closed (n/o)  Code	CTP Positive temperature coefficient thermistors probes  Code	Cable output ¹ Code
PLSES 180	MAPT 1011	MAPTF 101	MACTP 101	MASPC 109
PLSES 200	MAPT 1011	MAPTF 101	MACTP 101	MASPC 110
PLSES 225	MAPT 1011	MAPTF 101	MACTP 101	MASPC 111
PLSES 250	MAPT 1011	MAPTF 101	MACTP 101	MASPC 112
PLSES 280	MAPT 1011	MAPTF 101	MACTP 101	MASPC 113
PLSES 315	MAPT 1011	MAPTF 101	MACTP 101	MASPC 116
PLS 355				
PLS 400				

1. Cable length: 1 metre. Number of conductors: 6 + 1 (section according to the mains supply voltage and powers).

Use guide:

- STEP 1: Select the required basic motor according to the selection grids of the previous pages.
- STEP 2: Select the required additional option or options and add them to the basic designation.

Codification example:

PLSES open motor 37 kW 1500 min⁻¹ B3 foot, 400 V with anti-condensation heaters.

Designation
4P PLSES 200 M 37kW IM B3 400V → **Code**
4747846

↓ +

Anti-condensation heaters → MARE 1023

DG < 2 WD < 5 WD < To agree

DG: Availability ; n WD: Working Days (at the departure of the factory).