



sinamics

G110

SIEMENS

SINAMICS G110

The Compact version of the Operating Instructions will cover the majority of typical applications. It is valid for inverters firmware versions 1.0 and 1.1. For full details please refer to the Operating Instructions and the Parameter List.

Warnings, Cautions and Notes

The following Warnings, Cautions and Notes are provided for your safety and as a means of preventing damage to the product or components in the machines connected.

Specific Warnings, Cautions and Notes that apply to particular activities are listed at the beginning of the relevant chapters and are repeated or supplemented at critical points throughout these chapters.

Please read the information carefully, since it is provided for your personal safety and will also help prolong the service life of your SINAMICS G110 Inverter and the equipment you connect to it.



WARNING

- This equipment contains dangerous voltages and controls potentially dangerous rotating mechanical parts. Non-compliance with Warnings or failure to follow the instructions contained in this manual can result in loss of life, severe personal injury or serious damage to property.
 - Only suitable qualified personnel should work on this equipment, and only after becoming familiar with all safety notices, installation, operation and maintenance procedures contained in this manual. The successful and safe operation of this equipment is dependent upon its proper handling, installation, operation and maintenance.
 - The DC link of all SINAMICS G110 modules remains at a hazardous voltage level for 5 minutes after all voltages have been disconnected. Therefore always wait for 5 minutes after disconnecting the inverter from the power supply before carrying out work on any modules. The drive unit discharges itself during this time.
 - The mains input, DC and motor terminals carry dangerous voltages even if the inverter is inoperative, wait 5 minutes to allow the unit to discharge after switching off before carrying out any installation work.
 - During the parameter download with the STARTER commissioning tool or from the BOP to the inverter, the digital output may produce a spurious signal. Prior to performing a download to the inverter appropriate counter-measures must be taken to ensure that any suspended load is secured, for example, by the use of external brakes or the load being lowered to ground level and secured.
-

NOTES

- This equipment is capable of providing internal motor overload protection in accordance with UL508C section 42 (refer to P0610 and P0335). I²t monitoring is ON by default.
Motor overload protection can also be provided using an external PTC via a digital input.
 - This equipment is suitable for use in a circuit capable of delivering not more than 10,000 symmetrical amperes (rms), for a maximum voltage of 230 V when protected by an H or K type fuse, a circuit breaker or self-protected combination motor controller.
 - Use Class 1 75 °C copper wire only with the cross-sections as specified in Section 2.1
 - The maximum permissible ambient temperature is, depending on the equipment, 40 °C or 50 °C (refer to Section 2.1).
 - Before installing and commissioning, please read these safety instructions and warnings carefully and all the warning labels attached to the equipment.
 - Make sure that the warning labels are kept in a legible condition and replace missing or damaged labels.
-

Contents

1	Installation	6
1.1	Clearance distances for mounting	6
1.2	Mounting dimensions	6
2	Electrical Installation	7
2.1	Technical specifications	7
2.2	Power terminals	7
2.3	Control terminals	7
2.4	Block diagram	8
3	Factory setting	9
3.1	Specific factory settings for the analog version	9
3.2	Specific factory settings for the USS version	10
3.3	DIP switches	10
4	Communications	11
4.1	Establishing communications SINAMICS G110 ↔ STARTER	11
5	BOP (Option)	12
5.1	Buttons and their Functions	12
5.2	Changing parameters using as an example P0003 "Access level"	13
5.3	Cloning parameters with the BOP	14
6	Commissioning	15
6.1	Quick commissioning	15
6.2	Commissioning the application	17
6.2.1	Serial interface (USS)	17
6.2.2	Selection of command source	18
6.2.3	Digital inputs (DIN)	18
6.2.4	Digital output (DOUT)	19
6.2.5	Selection of frequency setpoint	19
6.2.6	Analog input (ADC)	20
6.2.7	Motor potentiometer (MOP)	20
6.2.8	Fixed frequency (FF)	21
6.2.9	JOG	21
6.2.10	Ramp-function generator (HLG)	22
6.2.11	Reference / limit frequencies	22
6.2.12	Motor control	22
6.2.13	Inverter/motor protection	24
6.2.14	Inverter-specific functions	24
6.3	Series commissioning	27
6.4	Parameter reset to factory setting	27
7	Displays and messages	27
7.1	LED status display	27
7.2	Fault messages and Alarm messages	27

1 Installation

1.1 Clearance distances for mounting

The inverters can be mounted adjacent to each other. If they are mounted on top of each other, however, a clearance of 100 mm has to be observed.

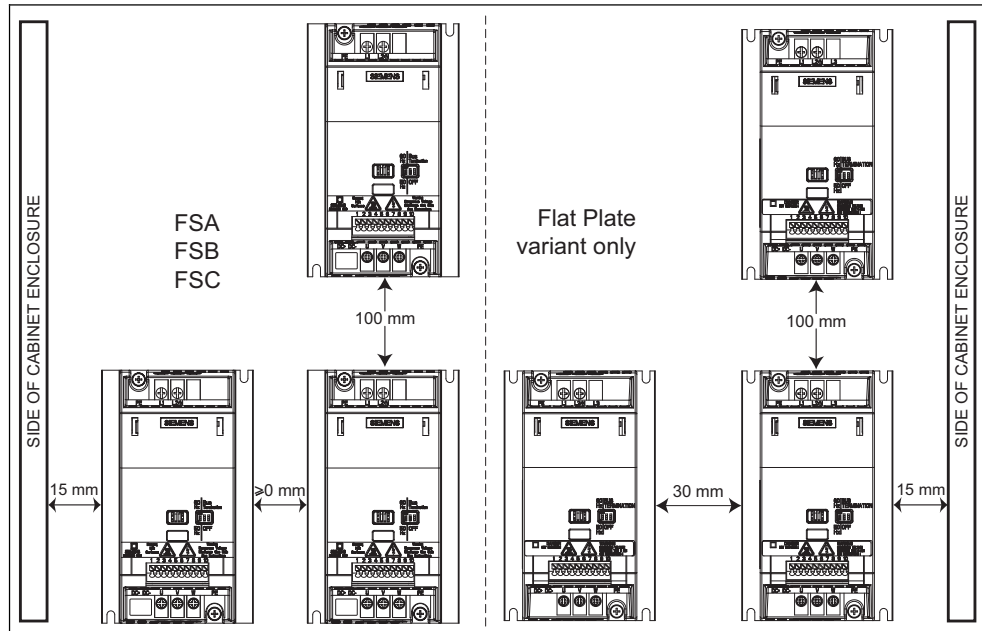

Fig. 1-1 Clearance distances for mounting

1.2 Mounting dimensions

	Frame Size	Drilling Dimensions		Tightening Torque	
		H mm (Inch)	W mm (Inch)	Bolts	Nm (lbf.in)
	A	140 (5.51)	79 (3.11)	2xM4	2,5 (22.12)
	B	135 (5.31)	127 (5.00)	4xM4	
	C	140 (5.51)	170 (6.70)	4xM5	4,0 (35.40)

Fig. 1-2 Mounting dimensions

2 Electrical Installation

2.1 Technical specifications

1 AC 200 - 240 V ± 10 %, 47 - 63 Hz

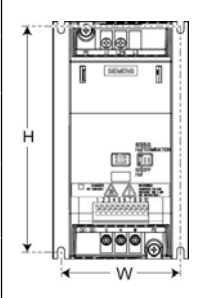
Order No. 6SL3211-	0AB 0KB	11-2xy0*	12-5xy0*	13xy0*	15xy0*	17xy0*	21-1xy0*	21-5xy0*	22-2xy0*	23-0xy0*
		11-2xy0*	12-5xy0*	13xy0*	15xy0*	17xy0*	-	-	-	-
Frame Size		A					B		C	
Inverter Output Rating	kW hp	0,12 0,16	0,25 0,33	0,37 0,5	0,55 0,75	0,75 1,0	1,1 1,5	1,5 2,0	2,2 3,0	3,0 4,0
Output Current (perm. ambient temp.)	A	0.9 (50 °C)	1.7 (50 °C)	2.3 (50 °C)	3.2 (50 °C)	3.9 (40 °C)	6.0 (50 °C)	7.8 (40 °C)	11.0 (50 °C)	13.6 (40 °C)
Input Current (230 V)	A	2.3	4.5	6.2	7.7	10.0	14.7	19.7	27.2	32.0
Recommended Fuse	A 3NA	10 3803	10 3803	10 3803	10 3803	16 3805	20 3807	25 3810	35 3814	50 3820
Input Cable	mm ² AWG	1,0 - 2,5 16 - 12	1,0 - 2,5 16 - 12	1,0 - 2,5 16 - 12	1,0 - 2,5 16 - 12	1,5 - 2,5 14 - 12	2,5 - 6,0 12 - 10	2,5 - 6,0 12 - 10	4,0 - 10 11 - 8	6,0 - 10 10 - 8
Output Cable	mm ² AWG	1,0 - 2,5 16 - 12	1,0 - 2,5 16 - 12	1,0 - 2,5 16 - 12	1,0 - 2,5 16 - 12	1,0 - 2,5 16 - 12	1,5 - 6,0 14 - 10	1,5 - 6,0 14 - 10	2,5 - 10 12 - 8	2,5 - 10 12 - 8
Tightening Torque of power terminals	Nm (lbf.in)	0.96 (8.50)					1.50 (13.30)		2.25 (19.91)	

*→ the last digit of the Order No. depends on hardware and software changes

x = A/B → with integrated filter
x = U → without filter

y = A → analog version
y = B → USS version

2.2 Power terminals

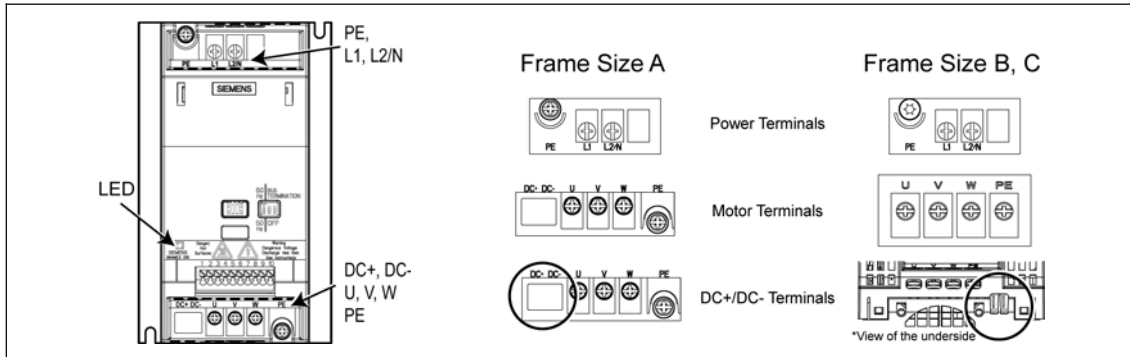



Fig. 2-1 Power Terminals

2.3 Control terminals

Term.	Designation	Function	
1	DOUT-	Digital output (-)	
2	DOUT+	Digital output (+)	
3	DIN0	Digital input 0	
4	DIN1	Digital input 1	
5	DIN2	Digital input 2	
6	-	Isolated output +24 V / 50 mA	
7	-	Output 0 V	
	Variant	Analog	USS
8	-	Output +10 V	RS485 P+
9	ADC	Analog input	RS485 N-
10	-	Output 0 V	



3 Factory setting

The SINAMICS G110 frequency inverter has already been programmed at the factory (motor parameters P0304, P0305, P0307, P0310), for standard V/f applications on Siemens 4-pole asynchronous motors 1LA that have the same power rating as the inverters

Further factory setting

Command sources	P0700 see Section 3.1/3.2
Setpoint source	P1000 see Section 3.1/3.2
Motor cooling	P0335 = 0 (self-cooled)
Motor current limit	P0640 = 150%
Min. frequency	P1080 = 0 Hz
Max. frequency	P1082 = 50 Hz
Ramp-up time	P1120 = 10 s
Ramp-down time	P1121 = 10 s
Control mode V/f	P1300 = 0 (V/f with linear characteristic)

3.1 Specific factory settings for the analog version

Digital input	Terminals	Parameter	Function
Command source	3, 4, 5	P0700 = 2	Digital input
Setpoint source	9	P1000 = 2	Analog input
Digital input 0	3	P0701 = 1	ON / OFF1 (I/O)
Digital input 1	4	P0702 = 12	Reverse (↺↻)
Digital input 2	5	P0703 = 9	Fault reset (Ack)
Control method	-	P0727 = 0	Siemens standard control

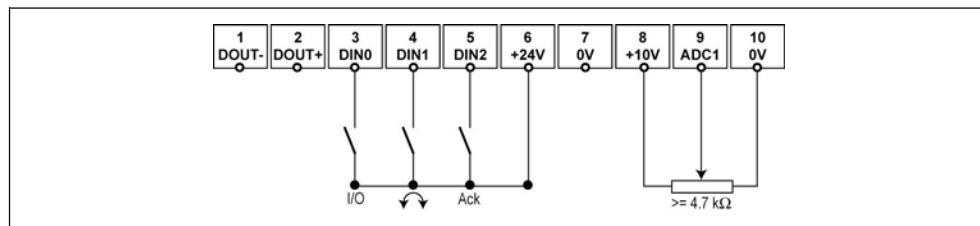

Fig. 3-1 Connections, analog version

3.2 Specific factory settings for the USS version

Inputs	Terminals	Parameter	Function
Command source	8, 9	P0700 = 5	Via the USS protocol
Setpoint source		P1000 = 5	Frequency input via the USS protocol
USS address		P2011 = 0	USS address = 0
USS baud rate		P2010 = 6	USS baud rate = 9600 bps
USS-PZD length		P2012 = 2	Two 16-bit words are in the PZD section of the USS telegram.

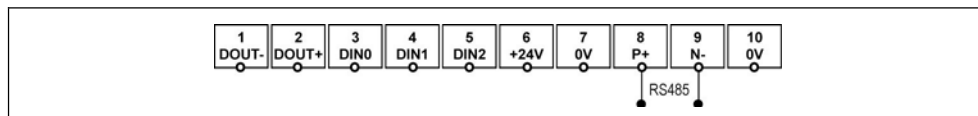

Fig. 3-2 Connections, USS version

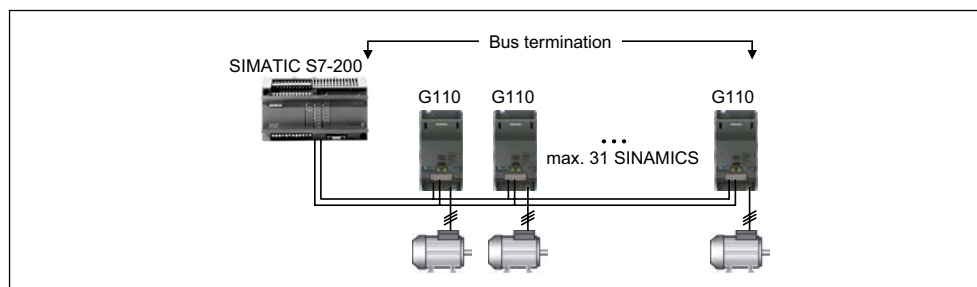

Fig. 3-3 Example, USS bus

3.3 DIP switches

The default motor base frequency of the SINAMICS G110 inverter is 50 Hz. For motors, which are designed for a base frequency of 60 Hz, the inverters can be set to this frequency via a DIP switch.

Bus termination on USS variant

It is necessary to terminate the last inverter on the network bus. This is achieved by setting the Bus Termination DIP switches (DIP switches 2 and 3) on the front of the inverter to the 'Bus Termination' position (ON position). A common 0 V reference (terminal 10) is required between all devices on the USS bus.



Fig. 3-4 Motor Base Frequency DIP Switch and Bus Termination

4 Communications

4.1 Establishing communications SINAMICS G110 ↔ STARTER

The following optional components are additionally required in order to establish communications between STARTER and SINAMICS G110:

- PC ↔ frequency inverter connecting kit (order no 6SL3255-0AA00-2AA0)
- BOP, as far as the USS standard settings already kept in the Sinamics G110 shall be changed (order no 6SL3255-0AA00-4BA0)

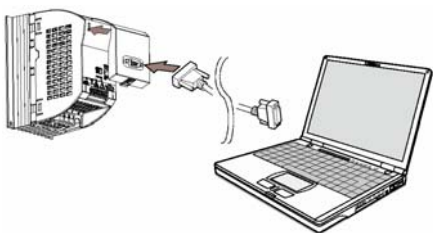
PC ↔ SINAMICS G110 connecting Kit	SINAMICS G110
	USS settings, refer to Section 6.2.1, Page 17.
	<p>STARTER</p> Menu, Options --> Set PG/PC interface --> Select "PC COM-Port (USS)" --> Properties --> Interface "COM1", select a baud rate
	<p>NOTE</p> The USS parameter settings in the SINAMICS G110 frequency inverter and the settings in STARTER must match!

5 BOP (Option)

5.1 Buttons and their Functions



Panel/ Button	Function	Effects
	Indicates Status	The LCD displays the settings currently used by the converter.
	Start converter	Pressing the button starts the converter. This button is disabled by default. Activate the button: P0700 = 1 or P0719 = 10 ... 15
	Stop converter	OFF1 Pressing the button causes the motor to come to a standstill at the selected ramp down rate. This button is disabled by default. Activate the button: P0700 = 1 or P0719 = 10 ... 15 OFF2 Pressing the button twice (or once long) causes the motor to coast to a standstill. This function is always enabled.
	Change direction	Press this button to change the direction of rotation of the motor. Reverse is indicated by a minus (-) sign or a flashing decimal point. Disabled by default. Activate the button: P0700 = 1 or P0719 = 10 ... 15.
	Jog motor	In the " Power-on/Ready" state, when this key is pressed, the motor starts and rotates with the pre-set jog frequency. The motor stops when the button is released. Pressing this button when the motor is running has no effect.
	Functions	This button can be used to view additional information. It works by pressing and holding the button. It shows the following, starting from any parameter during operation: 1. DC link voltage (indicated by d – units V) 2. output frequency (Hz) 3. output voltage (indicated by o – units V). 4. The value selected in P0005 (If P0005 is set to show any of the above (1 - 3) then this will not be shown again). Additional presses will toggle around the above displays. Jump Function From any parameter (rxxxx or Pxxxx) a short press of the Fn button will immediately jump to r0000, you can then change another parameter, if required. Upon returning to r0000, pressing the Fn button will return you to your starting point. Acknowledgement If alarm and fault messages are present, then these can be acknowledged by pressing key Fn.
	Access parameters	Pressing this button allows access to the parameters.
	Increase value	Pressing this button increases the displayed value.
	Decrease value	Pressing this button decreases the displayed value.

5.2 Changing parameters using as an example P0003 "Access level"

Step	Result on display
1 Press P to access parameters	r 0000
2 Press ▲ until P0003 is displayed	P 0003
3 Press P to access the parameter value level	1
4 Press ▲ or ▼ to the required value (example: 3)	3
5 Press P to confirm and store the value	P 0003
6 Now access level 3 is set and all level 1 to level 3 parameters are visible to the user.	

5.3 Cloning parameters with the BOP

A single parameter set can be uploaded from an inverter SINAMICS G110 and then downloaded into another SINAMICS G110 inverter. To clone a parameter set from one inverter to another, the following procedure should be performed:

Upload (SINAMICS G110 → BOP)

1. Connect the BOP to the inverter SINAMICS G110 which parameters you wish to copy.
2. Ensure that it is safe to stop the inverter.
3. Stop the inverter.
4. Set parameter P0003 to 3.
5. Set parameter P0010 to 30 to enter Cloning Mode.
6. Set parameter P0802 to 1 to start the upload from the Inverter to the BOP.
7. During the upload "BUSY" will be displayed.
8. The BOP and the inverter will not react to any commands during upload.
9. If the upload has been completed successfully, the BOP display will return to normal and the inverter will return to a ready state.
10. If the upload has failed:
Attempt another upload or perform a factory reset.
11. The BOP can now be removed from the inverter.

Download (BOP → SINAMICS G110)

1. Connect the BOP to the SINAMICS G110 inverter, in which the parameter set is to be downloaded.
2. Ensure power is applied to the inverter.
3. Set parameter P0003 to 3.
4. Set parameter P0010 to 30 to enter Cloning Mode.
5. Set parameter P0803 to 1 to start the download from the BOP to the inverter.
6. During the download "BUSY" will be displayed.
7. During download the BOP and the inverter will not react to any commands during download.
8. If the download has been completed successfully, the BOP display will return to normal and the inverter will return to a ready state.
9. If the download has failed:
Attempt another download or perform a factory reset.
10. The BOP can now be removed from the inverter.

NOTE

The following important restrictions should be considered when using the Cloning procedure:

- Only the current dataset is uploaded to the BOP.
 - Once the cloning procedure has started, it cannot be interrupted.
 - It is possible to copy data from inverters of different power and voltage ratings.
 - During download, if the data is not compatible with the inverter (e.g. different firmware releases) the default values for the parameter will be written to the inverter.
 - During the cloning process any data already held by the BOP is overwritten.
 - If the download or upload of data fails, the inverter will not function correctly.
-

6 Commissioning

6.1 Quick commissioning

The quick commissioning function will adapt the inverter to the motor and will set important technological parameters. The quick commissioning can be omitted if a 4-pole 1LA Siemens motor will be used, which matches the rating data of the frequency inverter.

In order to have access to all motor parameters it is recommended to set the user access level P0003=3 (see 5.2)

Parameters, designated with a * offer more setting possibilities than are actually listed here. Refer to the parameter list for additional setting possibilities.

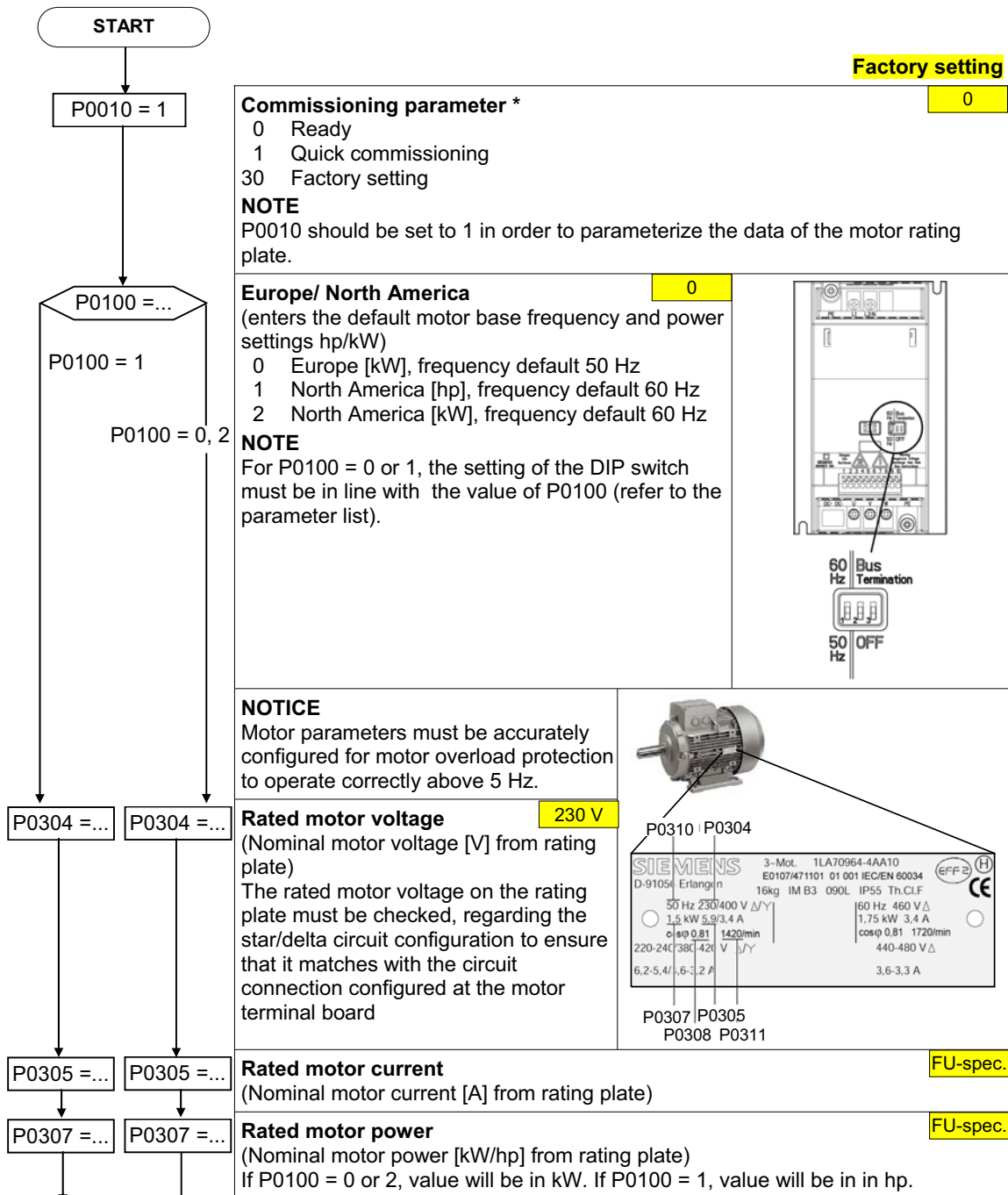

	<table border="1"> <tr> <td>Rated motor cosPhi (Nominal motor power factor (cos φ) from rating plate) If the setting is 0, the value is automatically calculated P0100 = 1: P0308 no significance, no entry required.</td> <td style="text-align: right;">0</td> </tr> <tr> <td>Rated motor efficiency (Nominal motor efficiency in [%] from rating plate) Setting 0 causes internal calculation of value. P0100 = 0, 2: P0309 no significance, no entry required.</td> <td style="text-align: right;">0</td> </tr> <tr> <td>Rated motor frequency (Nominal motor frequency in [Hz] from rating plate) Pole pair number recalculated automatically if parameter is changed.</td> <td style="text-align: right;">50.00 Hz</td> </tr> <tr> <td>Rated motor speed (Nominal motor speed in [rpm] from rating plate) Setting 0 causes internal calculation of value. NOTE For slip compensation, the input is absolutely necessary.</td> <td style="text-align: right;">FU-spec.</td> </tr> <tr> <td>Motor cooling (Selects motor cooling system used) 0 Self-cooled: Using shaft mounted fan attached to motor 1 Force-cooled: Using separately powered cooling fan</td> <td style="text-align: right;">0</td> </tr> <tr> <td>Motor overload factor (Motor overload factor in [%] relative to P0305) This defines the limit of the maximum output current as a % of the rated motor current (P0305).</td> <td style="text-align: right;">150 %</td> </tr> <tr> <td>Selection of command source (see Section 6.2.2 "Selection of command source") 0 Factory default setting 1 BOP (keypad) 2 Terminal 5 USS</td> <td style="text-align: right;">2 / 5</td> </tr> <tr> <td>Selection of frequency setpoint (see Section 6.2.5 "Selection of frequency setpoint") 1 MOP setpoint 2 Analog setpoint 3 Fixed frequency 5 USS</td> <td style="text-align: right;">2 / 5</td> </tr> <tr> <td>Min. frequency (enters the minimum motor frequency in Hz) Sets minimum motor frequency at which motor will run irrespective of frequency setpoint. The value set here is valid for both clockwise and anticlockwise rotation.</td> <td style="text-align: right;">0.00 Hz</td> </tr> <tr> <td>Max. frequency (enters the maximum motor frequency in Hz) Sets maximum motor frequency at which motor will run irrespective of the frequency setpoint. The value set here is valid for both clockwise and anticlockwise rotation.</td> <td style="text-align: right;">50.00 Hz</td> </tr> <tr> <td>Ramp-up time (enters the ramp-up time in s) Time taken for motor to accelerate from standstill up to maximum motor frequency (P1082) when no rounding is used.</td> <td style="text-align: right;">10.00 s</td> </tr> <tr> <td>Ramp-down time (enters the deceleration time in s) Time taken for motor to decelerate from maximum motor frequency (P1082) down to standstill when no rounding is used</td> <td style="text-align: right;">10.00 s</td> </tr> <tr> <td>OFF3 ramp-down time (enters the fast stop ramp-down time in s) Defines ramp-down time from maximum frequency to standstill for OFF3 command.</td> <td style="text-align: right;">5.00 s</td> </tr> </table>	Rated motor cosPhi (Nominal motor power factor (cos φ) from rating plate) If the setting is 0, the value is automatically calculated P0100 = 1: P0308 no significance, no entry required.	0	Rated motor efficiency (Nominal motor efficiency in [%] from rating plate) Setting 0 causes internal calculation of value. P0100 = 0, 2: P0309 no significance, no entry required.	0	Rated motor frequency (Nominal motor frequency in [Hz] from rating plate) Pole pair number recalculated automatically if parameter is changed.	50.00 Hz	Rated motor speed (Nominal motor speed in [rpm] from rating plate) Setting 0 causes internal calculation of value. NOTE For slip compensation, the input is absolutely necessary.	FU-spec.	Motor cooling (Selects motor cooling system used) 0 Self-cooled: Using shaft mounted fan attached to motor 1 Force-cooled: Using separately powered cooling fan	0	Motor overload factor (Motor overload factor in [%] relative to P0305) This defines the limit of the maximum output current as a % of the rated motor current (P0305).	150 %	Selection of command source (see Section 6.2.2 "Selection of command source") 0 Factory default setting 1 BOP (keypad) 2 Terminal 5 USS	2 / 5	Selection of frequency setpoint (see Section 6.2.5 "Selection of frequency setpoint") 1 MOP setpoint 2 Analog setpoint 3 Fixed frequency 5 USS	2 / 5	Min. frequency (enters the minimum motor frequency in Hz) Sets minimum motor frequency at which motor will run irrespective of frequency setpoint. The value set here is valid for both clockwise and anticlockwise rotation.	0.00 Hz	Max. frequency (enters the maximum motor frequency in Hz) Sets maximum motor frequency at which motor will run irrespective of the frequency setpoint. The value set here is valid for both clockwise and anticlockwise rotation.	50.00 Hz	Ramp-up time (enters the ramp-up time in s) Time taken for motor to accelerate from standstill up to maximum motor frequency (P1082) when no rounding is used.	10.00 s	Ramp-down time (enters the deceleration time in s) Time taken for motor to decelerate from maximum motor frequency (P1082) down to standstill when no rounding is used	10.00 s	OFF3 ramp-down time (enters the fast stop ramp-down time in s) Defines ramp-down time from maximum frequency to standstill for OFF3 command.	5.00 s
Rated motor cosPhi (Nominal motor power factor (cos φ) from rating plate) If the setting is 0, the value is automatically calculated P0100 = 1: P0308 no significance, no entry required.	0																										
Rated motor efficiency (Nominal motor efficiency in [%] from rating plate) Setting 0 causes internal calculation of value. P0100 = 0, 2: P0309 no significance, no entry required.	0																										
Rated motor frequency (Nominal motor frequency in [Hz] from rating plate) Pole pair number recalculated automatically if parameter is changed.	50.00 Hz																										
Rated motor speed (Nominal motor speed in [rpm] from rating plate) Setting 0 causes internal calculation of value. NOTE For slip compensation, the input is absolutely necessary.	FU-spec.																										
Motor cooling (Selects motor cooling system used) 0 Self-cooled: Using shaft mounted fan attached to motor 1 Force-cooled: Using separately powered cooling fan	0																										
Motor overload factor (Motor overload factor in [%] relative to P0305) This defines the limit of the maximum output current as a % of the rated motor current (P0305).	150 %																										
Selection of command source (see Section 6.2.2 "Selection of command source") 0 Factory default setting 1 BOP (keypad) 2 Terminal 5 USS	2 / 5																										
Selection of frequency setpoint (see Section 6.2.5 "Selection of frequency setpoint") 1 MOP setpoint 2 Analog setpoint 3 Fixed frequency 5 USS	2 / 5																										
Min. frequency (enters the minimum motor frequency in Hz) Sets minimum motor frequency at which motor will run irrespective of frequency setpoint. The value set here is valid for both clockwise and anticlockwise rotation.	0.00 Hz																										
Max. frequency (enters the maximum motor frequency in Hz) Sets maximum motor frequency at which motor will run irrespective of the frequency setpoint. The value set here is valid for both clockwise and anticlockwise rotation.	50.00 Hz																										
Ramp-up time (enters the ramp-up time in s) Time taken for motor to accelerate from standstill up to maximum motor frequency (P1082) when no rounding is used.	10.00 s																										
Ramp-down time (enters the deceleration time in s) Time taken for motor to decelerate from maximum motor frequency (P1082) down to standstill when no rounding is used	10.00 s																										
OFF3 ramp-down time (enters the fast stop ramp-down time in s) Defines ramp-down time from maximum frequency to standstill for OFF3 command.	5.00 s																										

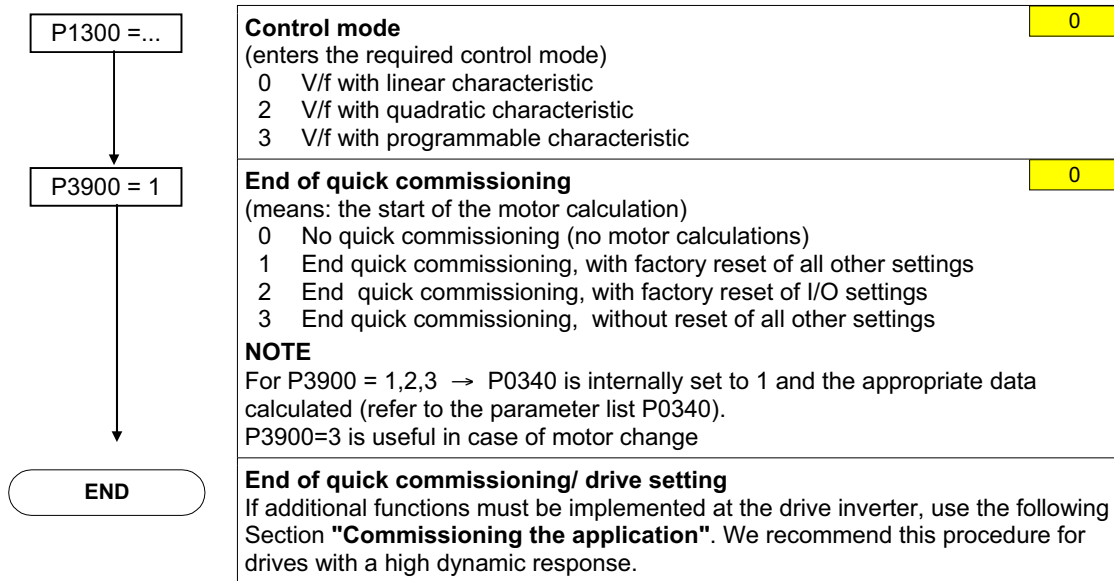

6.2 Commissioning the application

An application is commissioned to adapt/optimize the frequency inverter - motor combination to the particular application. The frequency inverter offers numerous functions - but not all of these are required for the particular application. These functions can be ignored when commissioning the application. A large portion of the possible functions are described here; refer to the parameter list for additional functions.

Parameters, designated with a * offer more setting possibilities than are actually listed here. Refer to the parameter list for additional setting possibilities.

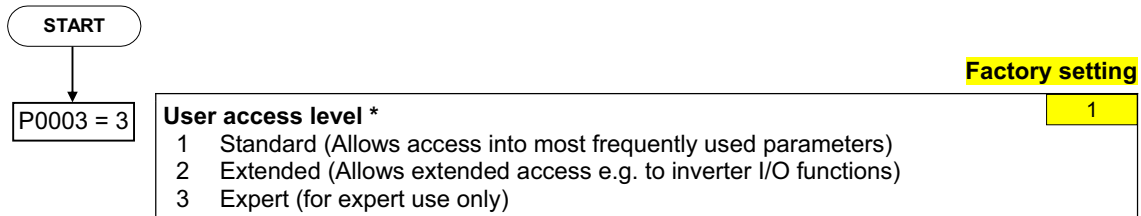

6.2.1 Serial interface (USS)

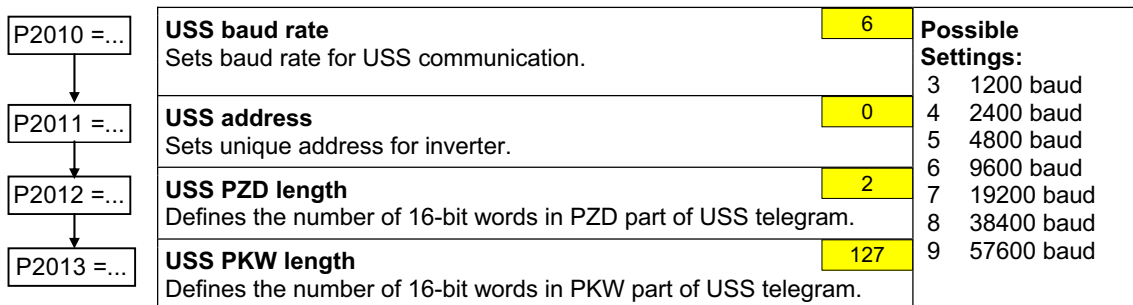

6.2.2 Selection of command source

P0700 =...	Selection of command source	2 / 5	P0700	G110 AIN	G110 USS	Settings
	Selects digital command source.		0	X	X	–
	0 Factory fault setting		1	X	X	–
	1 BOP (keypad)		2	X	X	See 6.2.3
	2 Terminal		5	–	X	See 6.2.1
5 USS						

6.2.3 Digital inputs (DIN)

P0701=...	Function of digital input 0	1	Possible Settings: 0 Digital input disabled 1 ON / OFF1 2 ON Reverse / OFF1 3 OFF2 – coast to standstill 4 OFF3 – quick ramp-down 9 Fault acknowledge 10 JOG right 11 JOG left 12 Reverse 13 MOP up (increase frequency) 14 MOP down (decrease frequency) 15 Fixed setpoint (Direct selection) 16 Fixed setpoint (Direct selection + ON) 21 Local/remote 25 DC brake enable 29 External trip See P0727 for redefinition of settings 1, 2, 12
↓	Terminal 3		
P0702=...	Function digital input 1	12	
↓	Terminal 4		
P0703=...	Function digital input 2	9	
↓	Terminal 5		
P0704=...	Function digital input 3	0	
↓	Via analog input (AIN version only)		
	Terminals 9, 10		
	FF selection (15, 16) not possible		
P0724=...	Debounce time for digital inputs	3	
↓	Defines debounce time (filtering time) used for digital inputs.		
	0 No debounce time		
	1 2.5 ms debounce time		
	2 8.2 ms debounce time		
	3 12.3 ms debounce time		

P0727 =...	2-wire/3wire control method	0
	Determines the control method using the terminals	
	0 Siemens Standard (Start / Direction)	
	1 2-wire (FWD / REV)	
	2 3-wire (FWD P / REV P)	
	3 3-wire (Start P / Direction)	
	"P" denotes "Pulse"; "FWD" denotes "FORWARD"; "REV" denotes "REVERSE"	

Redefined Digital Inputs

Settings P0701 – P0704	P0727=0 Siemens standard control	P0727=1 2-wire control	P0727=2 3-wire control	P0727=3 3-wire control
1	ON/OFF1	ON_FWD	STOP	ON_PULSE
2	ON REV/OFF1	ON_REV	FWDP	OFF1/HOLD
12	REV	REV	REVP	REV

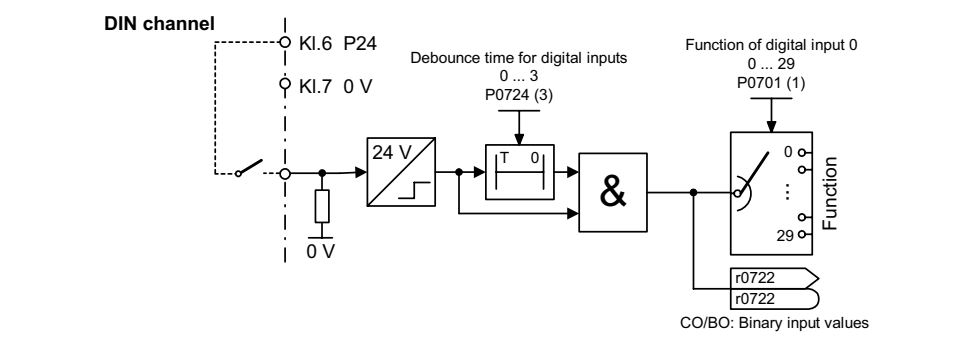

6.2.4 Digital output (DOUT)

P0731 =...

↓

P0748 = 0

Function of digital output 0*	Defines source of digital output 0.	5
Invert digital output	Allows the signals to be output to be inverted.	0
Status of DOUT at logically active signal (0 = Open; 1 = Closed)		
Frequent settings:	Active	Status
0 Not Active	-	0 (always)
1 Active	-	1 (always)
2 Drive ready	High	1
3 Drive ready to run	High	1
4 Drive running	High	1
5 Drive fault active	High	0
6 OFF2 active	Low	0
7 OFF3 active	Low	0
8 Switch on inhibit active	High	1
9 Drive warning active	High	1
10 Deviation between f_{set} and $f_{act} < 3$ Hz	High	1
11 PZD control (P0700=5)	High	1
12 Act. Freq \geq P1082 (f_{max})	High	1
13 Warning: Motor current limit	High	0
14 Motor holding brake active*	High	1
15 Motor overload	High	0

*Note: Motor holding brake active means the brake is open.

DOUT channel

6.2.5 Selection of frequency setpoint

P1000 =...

Selection of frequency setpoint	2 / 5	P1000	G110 AIN	G110 USS	Settings
0 No main setpoint		0	X	X	-
1 MOP setpoint		1	X	X	see 6.2.7
2 Analog setpoint		2	X	-	see 6.2.6
3 Fixed frequency		3	X	X	see 6.2.8
5 USS		5	-	X	see 6.2.1

6.2.6 Analog input (ADC)

P0757 =...

P0758 =...

P0759 =...

P0760 =...

P0761 =...

Value x1 of ADC scaling	0 V	<p>P0761 > 0 $0 < P0758 < P0760 \parallel 0 > P0758 > P0760$</p>
Value y1 of ADC scaling	0.0 %	
Value x2 of ADC scaling	10 V	
Value y2 of ADC scaling	100.0 %	
Width of ADC deadband	0 V	
<p>This parameter represents the value of x1 as a % of P2000 (reference frequency).</p> <p>This parameter represents the value of x2 as a % of P2000 (reference frequency).</p> <p>Defines width of deadband on analog input.</p>		

ADC channel

6.2.7 Motor potentiometer (MOP)

P1031 =...

P1032 =...

P1040 =...

Setpoint memory of the MOP	0	<p>Saves last motor potentiometer setpoint (MOP) that was active before OFF command or power down.</p> <p>0 MOP setpoint will not be stored</p> <p>1 MOP setpoint will be stored (P1040 is updated)</p>
Inhibit negative MOP setpoints	1	
Setpoint of the MOP	5.00 Hz	<p>Determines setpoint for motor potentiometer control.</p> <p>MOP ramp-up and ramp-down times are defined by the parameters P1120 and P1121.</p>

Possible parameter settings for the selection of MOP:

	Selection	MOP up	MOP down
DIN	P0719 = 0, P0700 = 2, P1000 = 1 or P0719 = 1, P0700 = 2	P0702 = 13 (DIN1)	P0703 = 14 (DIN2)
BOP	P0719 = 0, P0700 = 1, P1000 = 1 or P0719 = 1, P0700 = 1 or P0719 = 11	UP button	DOWN button
USS *)	P0719 = 0, P0700 = 5, P1000 = 1 or P0719 = 1, P0700 = 5 or P0719 = 51	USS control word r2036 Bit13	USS control word r2036 Bit14

*) SINAMICS G110 CPM110 USS only

6.2.8 Fixed frequency (FF)

There are 2 types of fixed frequencies:
 1. Direct selection (P0701 – P0703 =15)
 2. Direct selection + ON command (P0701 – P0703 = 16)
 For P0727 = 2, 3: if more than one setting '16' is used, each time the digital input (set to 16) receives a pulse, it will detach the previously assigned fixed frequency thus "overwriting the previously fixed frequency".
 For P0727= 1, 2, 3: at least one of the digital inputs is requested to be assigned 'setting 16' to allow an ON command to be issued

<div style="border: 1px solid black; padding: 2px; width: fit-content; margin-bottom: 5px;">P1001 =...</div> <div style="text-align: center;">↓</div> <div style="border: 1px solid black; padding: 2px; width: fit-content; margin-bottom: 5px;">P1002 =...</div> <div style="text-align: center;">↓</div> <div style="border: 1px solid black; padding: 2px; width: fit-content;">P1003 =...</div>	<p>Fixed frequency 1 0.00 Hz Defines the setpoint for the fixed frequency 1 (FF1) in Hz. Hinweis: Can be directly selected via DIN0 or USS (P0701 = 15, 16).</p> <p>Fixed frequency 2 5.00 Hz Can be directly selected via DIN1 or USS (P0701 = 15, 16).</p> <p>Fixed frequency 3 10.00 Hz Can be directly selected via DIN2 or USS (P0701 = 15, 16).</p>
--	---

6.2.9 JOG

<div style="border: 1px solid black; padding: 2px; width: fit-content; margin-bottom: 5px;">P1058 =...</div> <div style="text-align: center;">↓</div> <div style="border: 1px solid black; padding: 2px; width: fit-content;">P1060 =...</div>	<p>JOG frequency 5.00 Hz Frequency in Hz when the motor is being jogged in the selected direction of rotation.</p> <p>JOG ramp-up/down time 10.00 s Ramp-up/down time. The JOG ramp-up is limited by P1058.</p>	
--	---	--

6.2.10 Ramp-function generator (HLG)

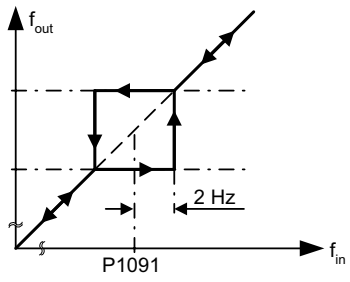
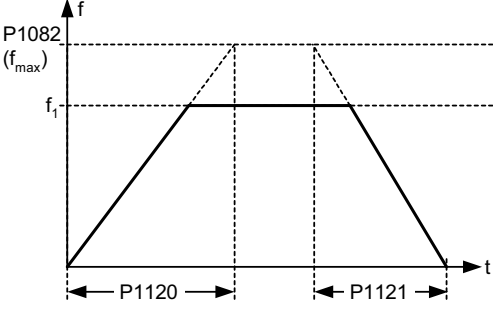
<p>P1091 =...</p> <p>↓</p> <p>P1120 =...</p> <p>↓</p> <p>P1121 =...</p> <p>↓</p> <p>P1130 =...</p> <p>↓</p> <p>P1134 =...</p> <p>↓</p> <p>P1135 =...</p>	<p>Skip frequency (entered in Hz) 0.00 Hz</p> <p>Defines skip frequency which avoids effects of mechanical resonance and suppresses frequencies within +/- 2 Hz (skip frequency bandwidth).</p> 
	<p>Ramp-up time (enters the accelerating time in s) 10.00 s</p> <p>Ramp-down time (enters the deceleration time in s) 10.00 s</p> <p>Ramp-up initial rounding time (entered in s) 0.00 s</p> <p>Rounding type</p> <p>0 Continuous smoothing</p> <p>1 Discontinuous smoothing</p> 
	<p>OFF3 ramp-down time 5.00 s</p> <p>Defines ramp-down time from maximum frequency to standstill for OFF3 command.</p>

6.2.11 Reference / limit frequencies

<p>P1080 =...</p> <p>↓</p> <p>P1082 =...</p> <p>↓</p> <p>P2000 =...</p>	<p>Min. frequency (entered in Hz) 0.00 Hz</p> <p>Sets minimum motor frequency [Hz] at which motor will run irrespective of frequency setpoint. If the setpoint falls below the value of P1080, then the output frequency is set to P1080 taking into account the sign.</p>
	<p>Max. frequency (entered in Hz) 50.00 Hz</p> <p>Sets maximum motor frequency [Hz] at which motor will run irrespective of the frequency setpoint. If the setpoint exceeds the value P1082, then the output frequency is limited. The value set here is valid for both clockwise and anticlockwise rotation.</p>
	<p>Reference frequency (entered in Hz) 50.00 Hz</p> <p>The reference frequency in Hertz corresponds to a value of 100 %. This setting should be changed if a maximum frequency of higher than 50 Hz is required. It is automatically changed to 60 Hz if the standard 60 Hz frequency was selected using the DIP50/60 switch or P0100.</p> <p>NOTE</p> <p>This reference frequency effects the setpoint frequency since both the analog setpoints (100% ≙ P2000) as well as the frequency setpoints via USS (4000H ≙ P2000) refer to this value.</p>

6.2.12 Motor control

<p>P1300 =...</p> <p>↓</p>	<p>Control mode 0</p> <p>The control type is selected using this parameter. For the "V/f characteristic" control type, the ratio between the frequency inverter output voltage and the frequency inverter output frequency is defined.</p> <p>0 V/f with linear</p> <p>2 V/f with quadratic characteristic</p> <p>3 V/f with programmable characteristic (→ P1320 – P1325)</p>
----------------------------	--

<p>P1310 =...</p>	<p>Continuous boost (entered in %) 50.00 %</p> <p>Voltage boost as a % relative to P0305 (rated motor current) and P0350 (stator resistance). P1310 is valid for all V/f characteristics (refer to P1300). At low output frequencies, the effective resistance values of the winding must be taken into account in order to maintain the motor flux.</p>
	<p>The graph shows the relationship between output voltage (V) and frequency (f). It is divided into a 'Boost voltage' region at low frequencies and a 'Linear V/f' region at higher frequencies. The boost region shows an 'actual V_{Boost}' curve that is higher than the 'Normal V/f (P1300 = 0)' line. Key points include V_{max}, V_n (P0304), and V_{ConBoost,100}. Frequency points include f_{Boost.end} (P1316), f_n (P0310), and f_{max} (P1082). The validity range diagram shows the drive's ON/OFF state and frequency f over time, with P1310 active during the ON state.</p>
<p>P1311 =...</p>	<p>Acceleration boost (entered in %) 0.0 %</p> <p>Voltage boost for accelerating/braking as a % relative to P0305 and P0350. P1311 only results in a voltage boost when ramping-up/ramp-down and generates an additional torque for accelerating/braking. Contrary to parameter P1312, that is only active for the 1st acceleration operation after the ON command, P1311 is effective each time that the drive accelerates or brakes.</p>
<p>P1312 =...</p>	<p>Starting boost (entered in %) 0.0 %</p> <p>Voltage boost when starting (after an ON command) when using the linear or quadratic V/f characteristic as a % relative to P0305 (rated motor current) or P0350 (stator resistance). The voltage boost remains active until</p> <ol style="list-style-type: none"> 1) the setpoint is reached for the first time and 2) the setpoint is reduced to a value that is less than the present ramp-function generator output.
<p>P1320 =...</p>	<p>Programmable V/f freq. coord. 1 0.0 Hz</p> <p>Sets V/f coordinates (P1320/1321 to P1324/1325) to define V/f characteristic.</p>
<p>P1321 =...</p>	<p>Programmable V/f volt. coord. 1 0.0 Hz</p>
<p>P1322 =...</p>	<p>Programmable V/f freq. coord. 2 0.0 Hz</p>
<p>P1323 =...</p>	<p>Programmable V/f volt. coord. 2 0.0 Hz</p>
<p>P1324 =...</p>	<p>Programmable V/f freq. coord. 3 0.0 Hz</p>
<p>P1325 =...</p>	<p>Programmable V/f volt. coord. 3 0.0 Hz</p>
	<p>The graph shows a piecewise linear V/f characteristic defined by coordinates (f₀, V₀) through (f₃, V₃). The final point is (f_n, V_n) where f_n is P0310 and V_n is P0304. The maximum voltage V_{max} is determined by V_{max} = f(V_{dc}, M_{max}). The formula for P1310 is given as: $P1310[V] = \frac{P1310[\%]}{100[\%]} \cdot P0350 \cdot \sqrt{3} \cdot P0305$.</p>
<p>P1334 =...</p>	<p>Slip compensation activation range (entered in %) 6.0 %</p> <p>Starting point for slip compensation is P1334 x P0310. Upper threshold is always P1334 + 4%</p>
<p>P1335 =...</p>	<p>Slip compensation (entered in %) 0.0 %</p> <p>Dynamically adjusts output frequency of inverter so that motor speed is kept constant independent of motor load.</p>

6.2.13 Inverter/motor protection

P0290 =...	Inverter overload reaction 0 Selects reaction of inverter to an internal overtemperature 0 Reduce output frequency 1 Trip (F0004 / F0005)
P0335 =...	Motor cooling (enters the motor cooling system) 0 0 Self-cooled: Using shaft mounted fan attached to motor 1 Force-cooled: Using separately powered cooling fan
P0610 =...	Motor I²t reaction 2 Defines reaction when motor I t reaches warning threshold. 0 Warning, no reaction, no trip 1 Warning, I _{max} reduction, 2 Warning, no I _{max} reduction, trip F0011
P0611 =...	Motor I²t time constant (entered in s) 100 s The time until the thermal limit of a motor is reached, is calculated via the thermal time constant. A higher value increases the time at which the motor thermal limit is reached. The value of P0611 is estimated according to the motor data during quick commissioning or is calculated using P0340 (Calculating of the motor parameters). When the calculation of motor parameters during quick commission is complete the stored value can be replaced by the value given by the motor manufacturer
P0614 =...	Motor I²t warning level (entered in %) 110.0 % Defines the value at which alarm A0511 (motor overtemperature) is generated.
P0640 =...	Motor overload factor [%] 150.0 % Defines motor overload current limit in [%] relative to P0305 (rated motor current). Limited to maximum inverter current or to 400 % of rated motor current (P0305), whichever is the lower.

6.2.14 Inverter-specific functions

6.2.14.1 Flying start

P1200 =...	Flying start 0 Starts inverter onto a spinning motor by rapidly changing the output frequency of the inverter until the actual motor speed has been found. 0 Flying start disabled 1 Flying start is always active, start in direction of setpoint 2 Flying start is active if power on, fault, OFF2, start in direction of setpoint 3 Flying start is active if fault, OFF2, start in direction of setpoint 4 Flying start is always active, only in direction of setpoint 5 Flying start is active if power on, fault, OFF2, only in direction of setpoint 6 Flying start is active if fault, OFF2, only in direction of setpoint
P1202 =...	Motor-current: Flying start (entered in %) 100 % Defines search current used for flying start.relative to rated motor current (P0305)
P1203 =...	Search rate: Flying start (entered in %) 100 % Sets factor by which the output frequency changes during flying start to synchronize with turning motor.

6.2.14.2 Automatic restart

P1210 =...	Automatic restart Configures automatic restart function. 0 Disabled 1 Trip reset after power on 2 Restart after mains blackout 3 Restart after mains brownout or fault 4 Restart after mains brownout 5 Restart after mains blackout and fault 6 Restart after mains brown/blackout or fault	1
-------------------	---	----------

6.2.14.3 Holding brake

P1215 =...	Holding brake enable Enables/disables holding brake function (MHB). 0 MBH disabled 1 MBH enabled NOTE The MHB is controlled via the signal of status word 1 r0052 bit 12. This signal can be issued via the digital output DOUT0 with parameter setting P0731=14 for controlling an external brake relay. In firmware version 1.0 r0052 bit 12 will be set when P1216 time has been passed.	0	
P1216 =...	Holding brake release delay (entered in s) Defines the time interval during which the frequency inverter runs with the min. frequency P1080, before ramping up	1.0 s	
P1217 =...	Holding time after ramp-down (entered in s) Defines time for which inverter runs at minimum frequency (P1080) after ramping down.	1.0 s	

6.2.14.4 DC braking & Compound braking

P1232 =...	DC braking current (entered in %) Defines level of DC current in [%] relative to rated motor current (P0305).	100 %
P1233 =...	Duration of DC braking (entered in s) Defines duration for which DC injection braking is to be active following an OFF1 or OFF3 command.	0 s
P1234 =...	DC braking start frequency (entered in Hz) Sets the start frequency for DC braking	650 Hz
P1236 =...	Compound braking current (entered in %) Defines DC level superimposed on AC waveform after exceeding DC link voltage threshold of compound braking. This value is entered in % relative to rated motor current (P0305). P1236=0 Compound braking disabled P1236=1 - 250 Level of DC braking current defined as % of rated motor current P0305	0 %

6.2.14.5 Vdc controller

P1240 =...

Configuration of Vdc controller

1

Enables / disables Vdc controller.

0 Vdc controller disabled

1 Vdc-max controller enabled

NOTE

P1240 = 1 prevents an overvoltage condition of the DC link (F0002) in regenerative operation by extending the ramp down time.

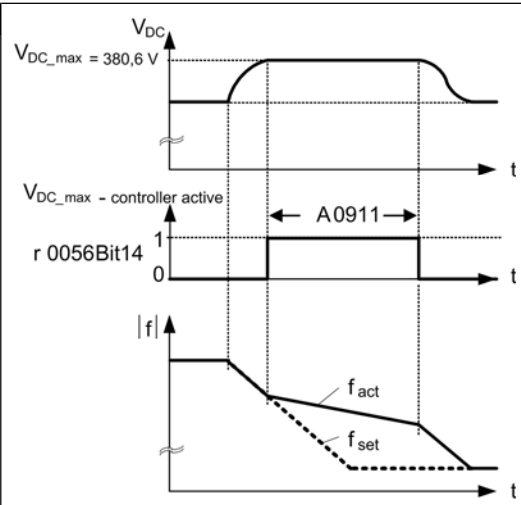

6.3 Series commissioning

An existing parameter set can be transferred to a SINAMICS G110 frequency inverter using STARTER or BOP (see 5.3). Typical applications for series commissioning include:

1. If several drives are to be commissioned that have the same configuration and same functions. A quick / application commissioning (first commissioning) must be carried-out for the first drive. Its parameter values are then transferred to the other drives.
2. When replacing SINAMICS G110 frequency inverters.

6.4 Parameter reset to factory setting

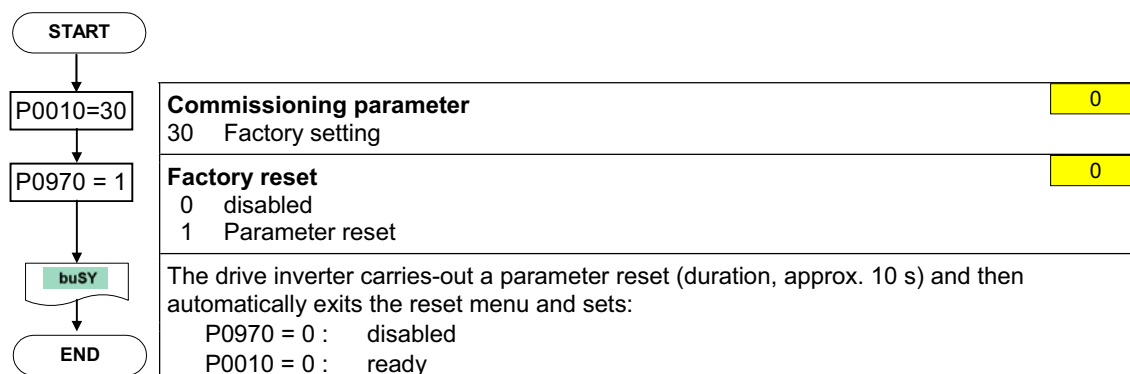

7 Displays and messages

7.1 LED status display

LED	Meaning	Position
LED Off	Inverter Off / No supply	
1000 ms On/1000 ms Off	Power On / Ready	
LED On steadily	Inverter Running	
500 ms On / 200 ms Off	General Warning	
100 ms On / 100 ms Off	Fault Condition	

7.2 Fault messages and Alarm messages

Fault	Significance
F0001	Overcurrent
F0002	Overvoltage
F0003	Undervoltage
F0004	Inverter Overtemperature
F0005	Inverter I ² t
F0011	Motor Overtemperature I ² t
F0051	Parameter EEPROM Fault
F0052	Powerstack Fault
F0060	Asic Timeout
F0072	USS setpoint fault
F0085	External Fault

Alarms	Significance
A0501	Current Limit
A0502	Overvoltage limit
A0503	Undervoltage Limit
A0505	Inverter I ² t
A0511	Motor Overtemperature I ² t
A0910	Vdc-max controller de-activated
A0911	Vdc-max controller active
A0920	ADC parameters not set properly
A0923	Both JOG Left and JOG Right are requested

Information about SINAMICS G110 is also available from:

Regional Contacts

Please get in touch with your contact for Technical Support in your Region for questions about services, prices and conditions of Technical Support.

Central Technical Support

The competent consulting service for technical issues with a broad range of requirements-based services around our products and systems.

Europe / Africa

Tel: +49 (0) 180 5050 222

Fax: +49 (0) 180 5050 223

Email: adsupport@siemens.com

America

Tel: +1 423 262 2522

Fax: +1 423 262 2289

Email: simatic.hotline@sea.siemens.com

Asia / Pacific

Tel: +86 1064 719 990

Fax: +86 1064 747 474

Email: adsupport.asia@siemens.com

Online Service & Support

The comprehensive information system available round the clock via the Internet, ranging from Product Support and Service & Support services to the Support Tools in the Shop. <http://www.siemens.com/automation/service&support>

Internet Home Address

Customers can access technical and general information at:
<http://www.siemens.com/sinamics-g110>